

## Datasheet - AZ 16-12ZVK

Safety switch with separate actuator / AZ 16



- thermoplastic enclosure
- Double-insulated
- Large wiring compartment
- 52 mm x 90 mm x 30 mm
- Multiple coding
- Long life
- High level of contact reliability with low voltages and currents
- Slotted holes for adjustment, circular holes for location
- 3 cable entries M 16 x 1.5

(Minor differences between the printed image and the original product may exist!)

### Ordering details

Product type description	AZ 16-12ZVK
Article number	1152725
EAN code	4030661166247

### Approval

Approval

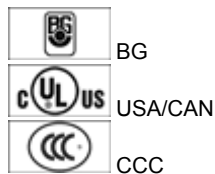

### Classification

Standards	EN ISO 13849-1
B <sub>10d</sub> Opener (NC)	2.000.000
B <sub>10d</sub> Normally open contact (NO)	1.000.000
- notice	at 10% I <sub>e</sub> and ohmic load
Mission time	20 Years
notice	$MTTF_d = \frac{B_{10d}}{0,1 \times n_{op}}$ $n_{op} = \frac{d_{op} \times h_{op} \times 3600 \text{ s/h}}{t_{zyklus}}$

### Global Properties

Product name	AZ 16
Standards	EN 60947-5-1, BG-GS-ET-15

Compliance with the Directives (Y/N) 

Yes

#### Materials

- Material of the housings	Plastic, glass-fibre reinforced thermoplastic, self-extinguishing
- Material of the contacts	Silver
Housing coating	None
Weight	120 g

### Mechanical data

---

Design of electrical connection	Screw connection
Cable section	
- Min. Cable section	0,75 mm <sup>2</sup>
- Max. Cable section	2.5 mm <sup>2</sup>
Mechanical life	20.000.000 operations
higher Latching force (Y/N)	No
With ejection force (Y/N)	Yes
Positive break force	20 N
positive break travel	8 mm
Max. Actuating speed	0,2 m/s
notice	All indications about the cable section are including the conductor ferrules.

### Ambient conditions

---

Ambient temperature	
- Min. environmental temperature	- 30°C
- Max. environmental temperature	+ 80°C
Protection class	IP67 to IEC/EN 60529

### Electrical data

---

Design of control element	Normally open contact (NO), Opener (NC)
Switching principle	Creep circuit element
Number of auxiliary contacts	1 piece
Number of safety contacts	2 piece
Rated impulse withstand voltage U <sub>imp</sub>	6 kV
Rated insulation voltage U <sub>i</sub>	500 V
Thermal test current I <sub>the</sub>	10 A
Utilisation category	AC-15: 230 V / 4 A, DC-13: 24 V / 4 A
Max. fuse rating	6 A gG D-fuse

### ATEX

---

Explosion protection categories for gases	None
Explosion protected category for dusts	None

### Dimensions

---

Dimensions of the sensor	
- Width of sensor	52 mm
- Height of sensor	90 mm
- Length of sensor	30 mm

### Included in delivery

Actuators must be ordered separately.

## Diagram

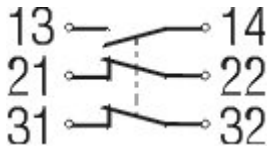

Note Diagram

- positive break NC contact
- active
- no active
- Normally-open contact
- Normally-closed contact

## Switch travel diagram

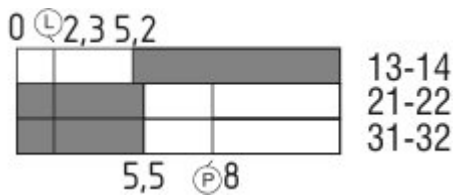

Notes Switch travel diagram

- Contact closed
- Contact open
- Setting range
- Break point
- Positive opening sequence/- angle
- VS** adjustable range of NO contact
- VÖ** adjustable range of NC contact
- N** after travel

## Ordering suffix

The applicable ordering suffix is added at the end of the part number of the safety switch.

Order example: AZ 16-12ZVK- **1762**

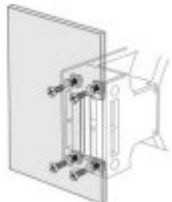

...- **1762**

Versions with M5 nuts  
For front mounting of safety switch, e.g. on sheet-steel covers  
Cannot be retrofitted

...-**1637**

With gold-plated contacts (0,3 µm), ordering suffix -1637

...- **M20**

cable entries M20

## Ordering code

---

AZ 16-(1)ZV(2)K-(3)-(4)-(5)

(1)

*without* 1 Normally open contact (NO) / 1 Opener (NC)

**02** 2 Opener (NC)

**03** 3 Opener (NC)

**12** Normally open contact (NO) 1 / Opener (NC) 2

(2)

*without* Ejection force

**R** Latching force 30 N

(3)

**G24** with LED (*only available for version with one NO and one NC contact.*)

(4)

*without* Cable entry M16

**M20** Cable entry M20

**ST** Connector M12, 4-pole, bottom

**STL** Connector M12, 4-pole, left

**STR** Connector M12, 4-pole, right

(5)

**2254** Latching force 5 N

**1762** Front mounting

**1637** gold-plated contacts

## Documents

---

**Operating instructions and Declaration of conformity** (de) 427 kB, 21.01.2010

[http://www.schmersal.net/Bilddata/AZ/Pdf/Az15\\_16/bedien/DE/mrl\\_az15-16\\_de.pdf](http://www.schmersal.net/Bilddata/AZ/Pdf/Az15_16/bedien/DE/mrl_az15-16_de.pdf)

**Operating instructions and Declaration of conformity** (pt) 445 kB, 02.03.2010

[http://www.schmersal.net/Bilddata/AZ/Pdf/Az15\\_16/bedien/pt/mrl\\_az15-16i\\_pt.pdf](http://www.schmersal.net/Bilddata/AZ/Pdf/Az15_16/bedien/pt/mrl_az15-16i_pt.pdf)

**Operating instructions and Declaration of conformity** (es) 349 kB, 27.11.2009

[http://www.schmersal.net/Bilddata/AZ/Pdf/Az15\\_16/bedien/ES/mrl\\_az15-16\\_es.pdf](http://www.schmersal.net/Bilddata/AZ/Pdf/Az15_16/bedien/ES/mrl_az15-16_es.pdf)

**Operating instructions and Declaration of conformity** (it) 330 kB, 27.11.2009

[http://www.schmersal.net/Bilddata/AZ/Pdf/Az15\\_16/bedien/IT/mrl\\_az15-16\\_it.pdf](http://www.schmersal.net/Bilddata/AZ/Pdf/Az15_16/bedien/IT/mrl_az15-16_it.pdf)

**Operating instructions and Declaration of conformity** (nl) 344 kB, 27.11.2009

[http://www.schmersal.net/Bilddata/AZ/Pdf/Az15\\_16/bedien/NL/mrl\\_az15-16\\_nl.pdf](http://www.schmersal.net/Bilddata/AZ/Pdf/Az15_16/bedien/NL/mrl_az15-16_nl.pdf)

**Operating instructions and Declaration of conformity** (en) 435 kB, 21.01.2010

[http://www.schmersal.net/Bilddata/AZ/Pdf/Az15\\_16/bedien/EN/mrl\\_az15-16\\_en.pdf](http://www.schmersal.net/Bilddata/AZ/Pdf/Az15_16/bedien/EN/mrl_az15-16_en.pdf)

**Operating instructions and Declaration of conformity** (jp) 526 kB, 27.11.2009

[http://www.schmersal.net/Bilddata/AZ/Pdf/Az15\\_16/bedien/JP/mrl\\_az15-16\\_jp.pdf](http://www.schmersal.net/Bilddata/AZ/Pdf/Az15_16/bedien/JP/mrl_az15-16_jp.pdf)

**Operating instructions and Declaration of conformity** (fr) 430 kB, 27.11.2009

[http://www.schmersal.net/Bilddata/AZ/Pdf/Az15\\_16/bedien/FR/mrl\\_az15-16\\_fr.pdf](http://www.schmersal.net/Bilddata/AZ/Pdf/Az15_16/bedien/FR/mrl_az15-16_fr.pdf)

**BG-test certificate** (en) 1 MB, 07.03.2007

[http://www.schmersal.net/Bilddata/AZ/Pdf/Az15\\_16/baumuste/z\\_z15p02.pdf](http://www.schmersal.net/Bilddata/AZ/Pdf/Az15_16/baumuste/z_z15p02.pdf)

**BG-test certificate** (de) 2 MB, 07.03.2007

[http://www.schmersal.net/Bilddata/AZ/Pdf/Az15\\_16/baumuste/z\\_z15p01.pdf](http://www.schmersal.net/Bilddata/AZ/Pdf/Az15_16/baumuste/z_z15p01.pdf)

**CCC certification** (cn) 730 kB, 12.12.2006

[http://www.schmersal.net/Bilddata/AZ/Pdf/Az15\\_16/zertifikat/q\\_175p03.pdf](http://www.schmersal.net/Bilddata/AZ/Pdf/Az15_16/zertifikat/q_175p03.pdf)

**Gost certification** (ru) 1 MB, 21.06.2007

[http://www.schmersal.net/Bilddata/AZ/Pdf/Az15\\_16/zertifikat/q\\_az1p01.pdf](http://www.schmersal.net/Bilddata/AZ/Pdf/Az15_16/zertifikat/q_az1p01.pdf)

## Images

---

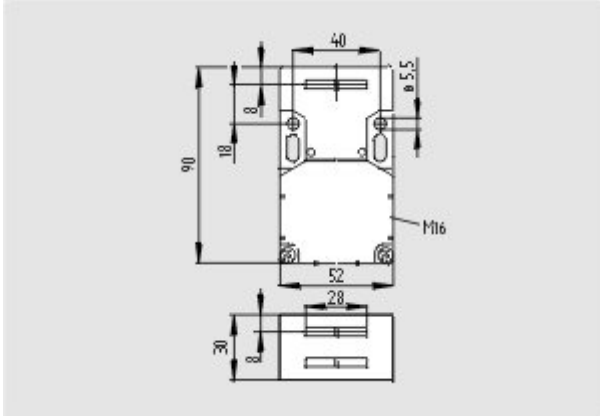

Dimensional drawing (basic component)

---

## System components

---

### Actuator

**1083036 - AZ 15/16-B1**



**1092711 - AZ 15/16-B1-1747**



- For play-free interlocking of light guards
- Suitable for retrofitting

**1093553 - AZ 15/16-B1-1747**



- For play-free interlocking of light guards
- The magnetic latch can be easily fitted in any actuating plane
- Suitable for retrofitting

**1108276 - AZ 15/16-B1-2024**

---



**1108278 - AZ 15/16-B1-2024 WITH SLOT SEALING PLUG**

- For protection against the ingress of course dirt



**1111079 - AZ 15/16-B1-2053**

- For interlocking of light to medium-weight guards



**1111081 - AZ 15/16-B1-2053 WITH BALL LATCH**

- For interlocking of light to medium-weight guards



**1126793 - AZ 15/16-B1-2177**

- For interlocking of light, unguided guards



**1126794 - AZ 15/16-B1-2177 WITH CENTERING GUIDE**

- For interlocking of light, unguided guards



**1137408 - AZ 15/16-B1-2245**

- Damps vibration on guard device



**1095558 - AZ 15/16-B2**

- For very small actuating radii in line with the plane of the actuator



**1096091 - AZ 15/16-B2-1747**

- For very small actuating radii in line with the plane of the actuator
- Suitable for retrofitting
- For play-free interlocking of light guards



**1096089 - AZ 15/16-B2-1747 WITH MAGNETIC LATCH**

- For very small actuating radii in line with the plane of the actuator
- Suitable for retrofitting
- For play-free interlocking of light guards
- The magnetic latch can be easily fitted in any actuating plane



**1095550 - AZ 15/16-B3**

- For very small actuating radii at 90° to the plane of the actuator



**1096090 - AZ 15/16-B3-1747 WITH MAGNETIC LATCH**

- For very small actuating radii at 90° to the plane of the actuator
- Suitable for retrofitting
- For play-free interlocking of light guards
- The magnetic latch can be easily fitted in any actuating plane



**1096092 - AZ 15/16-B3-1747**

- For very small actuating radii at 90° to the plane of the actuator
- Suitable for retrofitting
- For play-free interlocking of light guards



**1137434 - AZ 15/16-B6**

- For very small actuating radii in line with or at 90° to the plane of the actuator

---

**Door-handle system**



**AZ 16-ST30**

- Latching handle
- Suitable for all types of guard

---

**Accessories**

**1149214 - Mounting set MS AZ 15/16 R/P**

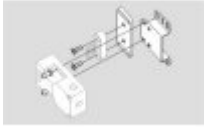

---

**1150373 - Mounting set MS AZ 15/16 P**

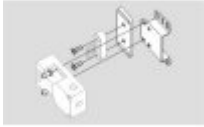

---

**1089116 - Slot sealing plugs AZ 15/16-1476**

- For protection against the ingress of course dirt
- To cover unused actuator slots
- Simple clip-in fitting



---

**1115025 - Ball latch 2053-2**

- Additional ball latch for stable latching of light to medium-weight guards
- For separate mounting on the guard



---

**1110500 - SZ 16/335**

- To prevent inadvertent closing, e.g. during maintenance
- For complex plant
- Prevents actuation of the switch
- Up to 6 padlocks can be fitted
- The lockout tag can be mounted on a chain near to the safety switch



---

**Mounting accessories**



---

**1135338 - TAMPERPROOF SCREWS  
M 5 x 12**

- To mount the actuator
- Higher protection against tampering with interlock
- Protects against unauthorised removal of actuator
- Various lengths available



---

**1135339 - TAMPERPROOF SCREWS M 5 x 16**

- To mount the actuator
- Higher protection against tampering with interlock
- Protects against unauthorised removal of actuator
- Various lengths available

---

**1135340 - TAMPERPROOF SCREWS M 5 x 20**

- To mount the actuator
- Higher protection against tampering with interlock
- Protects against unauthorised removal of actuator
- Various lengths available





---

K.A. Schmersal GmbH, Möddinghofe 30, D-42279 Wuppertal  
The data and values have been checked thoroughly. Technical modifications and errors excepted.  
Generiert am 25.03.2010 - 15:38:27h Kasbase 1.3.5 DBI